



SCHWERT
SWORD · ESPADA
EPEE · SPADA

SCHWERT

IDS 2023

Special



Die neuen ERGO DESIGN Universalgriffe

The all new ERGO DESIGN universal handles



3200-01
violett
purple
3200-11
einendig
single-ended

3200-02
blau
blue
3200-12
einendig
single-ended

3200-03
grau
grey
3200-13
einendig
single-ended

3200-04
schwarz
black
3200-14
einendig
single-ended

3200-05
gelb
yellow
3200-15
einendig
single-ended

3200-06
grün
green
3200-16
einendig
single-ended

3200-07
orange
orange
3200-17
einendig
single-ended

3200-08
hellrot-magenta
lightred magenta
3200-18
einendig
single-ended

3200-09
türkis
turquoise
3200-19
einendig
single-ended

3300-21
Endkappe für
doppelendige
Griffe mit
M4 x 0,5 Gewinde
zur einendigen
Nutzung
End cap for
double-ended
handles with
M4 x 0.5 thread
for single-ended
usage

i SCHWERT ERGO DESIGN Griffe · SCHWERT ERGO DESIGN handles

SCHWERT Ergo Griff mit dickerem Durchmesser als unser **CoLoR CODE** Griff für ermüdungsfreieres und präzises Arbeiten. Doppelendig, für alle gängigen dentalen Einsätze mit einem M4 x 0,5 Gewinde. Die Griffe sind Dank der thermischen und chemischen Eigenschaften des hochwertigen Peek Kunststoffes völlig unbedenklich in der Hygienekette. **NEU:** Die Griffe sind nur noch 10 cm lang, was es erlaubt, dass die meisten montierten Instrumente nun besser in unsere PROTECTOR Trays und Waschkörbe passen.

SCHWERT Ergo handles, with thicker diameter as our **CoLoR CODE** handle for more fatigueless and precise working. Double ended, for all common dental inserts with M4 x 0.5 thread. The handles are thanks to Peek's thermic and chemical characteristics completely unproblematic in the maintenance chain **NEW:** The handles are only 10 cm long, which allows for the most assembled instruments to fit better in our PROTECTOR trays and washing baskets.



SCHWERT
SWORD · ESPADA
EPEE · SPADA

TAC-TRACTION



140-59

FIG. 59, 15,0 cm
Extra schmal für Wurzeln
Extra slim for roots



140-67LX

FIG. 67LX, 17,5 cm



140-67RX

FIG. 67RX, 17,5 cm

i

TAC-Traction Zahnzangen TAC-Traction extraction forceps

SCHWERT TAC-Traction Zahnzangen gewährleisten eine ausgewogene Luxation bei gutem Tastgefühl durch bis zu 25% Gewichtseinsparung.

SCHWERT TAC-Traction extraction forceps allow a balanced luxation, combined with an amazing tactile feeling, due to approx. 25% weight saving.

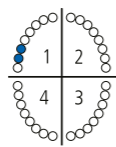
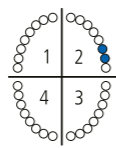

1490-50

Levy Elevator 18-28
Extra starkes Chompret Syndesmotom zur 8er Extraktion, 21 cm Länge
Levy Elevator 18-28
Extra strong Chompret syndesmotome for wisdom tooth extraction, 21 cm long



1490-60

Levy Elevator 38/48
Beck Heber Figur 2, 3,5 mm, mit langem Schaft, 21 cm Länge
Levy elevator 38/48
Beck tip figure 2, 3.5 mm, with long shaft, 21 cm length

12.2023



SCHWERT
SWORD · ESPADA
EPEE · SPADA

i

P-LUX Periotom · P-Lux Periotome

Mit Skala zur Tiefenmessung während des Trennens der Sharpey'schen Fasern

With scale for depth measuring while cutting the Sharpey' fibres.

P-LUX



617-20S

P-Lux Periotom flexibel, gerade, mit CP15 Skalierung, 15 mm in 1 mm Schritten, 16,5 cm Länge
P-Lux Periotome, flexible, straight, with CP15 scaling, 15 mm in 1 mm steps, 16.5 cm length



1706-10

Periotom P2 / P3 Kombination, auswechselbar, M4 x 0,5 mm, Breiten 1,7 mm / 1,7 mm
Periotome P2 / P3, combination, exchangeable, M4 x 0.5 mm, widths 1.7 mm / 1.7 mm



618-01

Approximal Desmotom, Fig. 0, gerade, 3,0 mm, auswechselbar, M4x 0,5, einendig
Approximal desmotome, fig. 0, straight, 3.0 mm, exchangeable, M4 x 0.5, single end



618-02

Approximal Desmotom, Fig. 4, distal, Biegung, 3,0 mm, auswechselbar, M4 x 0,5, einendig
Approximal desmotome, fig. 4, distal, 3.0 mm, exchangeable, M4 x 0.5, single end



618-03

Approximal Desmotom, Fig. 5, mesial, Biegung, 3,0 mm, auswechselbar, M4 x 0,5, einendig
Approximal desmotome, fig. 5, mesial, 3.0 mm, exchangeable, M4 x 0.5, single end

12.2023



i

SAFE-EX 2 Skalpellgriff · SAFE-EX 2 Scalpel blade holder

Neues Design und verbesserte Abwurf-Funktion für noch sichereres Arbeiten. Vereinfachter Zusammenbau zur besseren Reinigung.

New design and improved drop off function for easier working. More convenient mantling for better maintenance.

SAFE-EX 2
patented



1033-61 Skalpellgriff SAFE-EX 2, Klingenthaler, mit Abwurffunktion, 15 cm
Scalpel blade holder SAFE-EX 2 with eject function, 15 cm



1402-10 Gingiva-Abhalter im Schwert Design Griff, Länge: 17,5cm, Breite: 7,5mm & 4mm
Gingiva retractor in Schwert design, handle, Length: 17.5cm, Width: 7.5mm & 4mm



1705-100-00E

Tunnelier Kit, beinhaltet:
1705-2-01E, 1705-3-04E, 1705-16-07E,
1705-4, SCHWERT Protector-Tray 2597-05
Tunneling Kit, consisting of:
1705-2-01E, 1705-3-04E, 1705-16-07E,
1705-4, SCHWERT Protector-Tray 2597-05

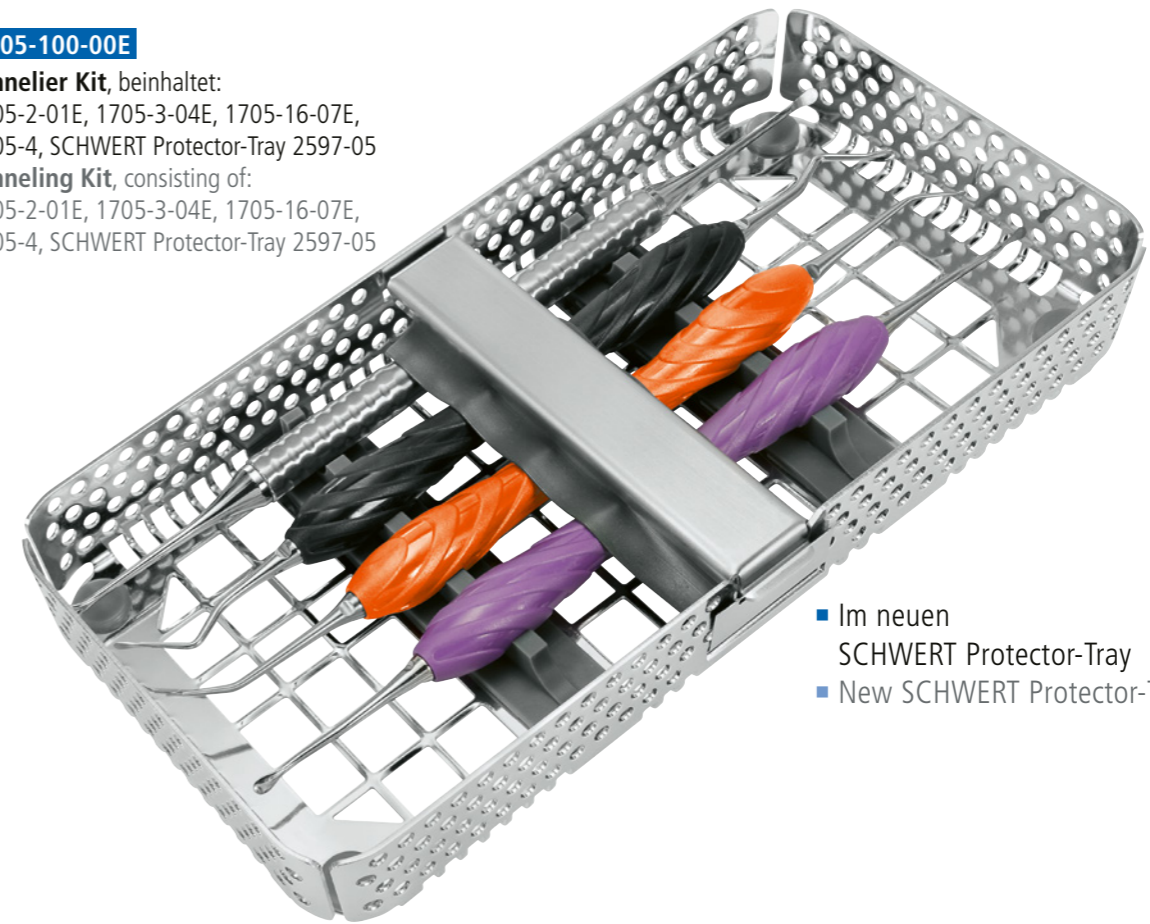

- Im neuen SCHWERT Protector-Tray
- New SCHWERT Protector-Tray



1705-2-01E Tunneliermesser FIG. 1, 1,9 / 2,5 mm, Oberkiefer, auswechselbar
Tunneling knife FIG. 1, 1.9 / 2.5 mm, maxilla, exchangeable



1705-3-04E Tunneliermesser FIG. 2, 1,9 / 2,5 mm, Unterkiefer, auswechselbar
Tunneling knife FIG. 2, 1.9 / 2.5 mm, mandible, exchangeable



1705-16-07E Papillenheber, 1,5 / 2,5 mm, 17,5 cm, auswechselbar
Papilla elevator, 1.5 / 2.5 mm, 17.5 cm, exchangeable



1705-4 Mucoperiostalelevator
Micro flap elevator



i

Universal Chirurgie Set · Universal surgical kit

Universal Chirurgie Set für alle gängigen chirurgischen oder mikrochirurgischen Eingriffe. Im neuen SCHWERT Ergo Griff für ermüdungsfreies und präzises Operieren.

Universal surgical kit for all common surgical or micro surgical treatments. In the new SCHWERT Ergo handle for fatigue less and precise operating.

SCHWERT
SWORD · ESPADA
EPEE · SPADA

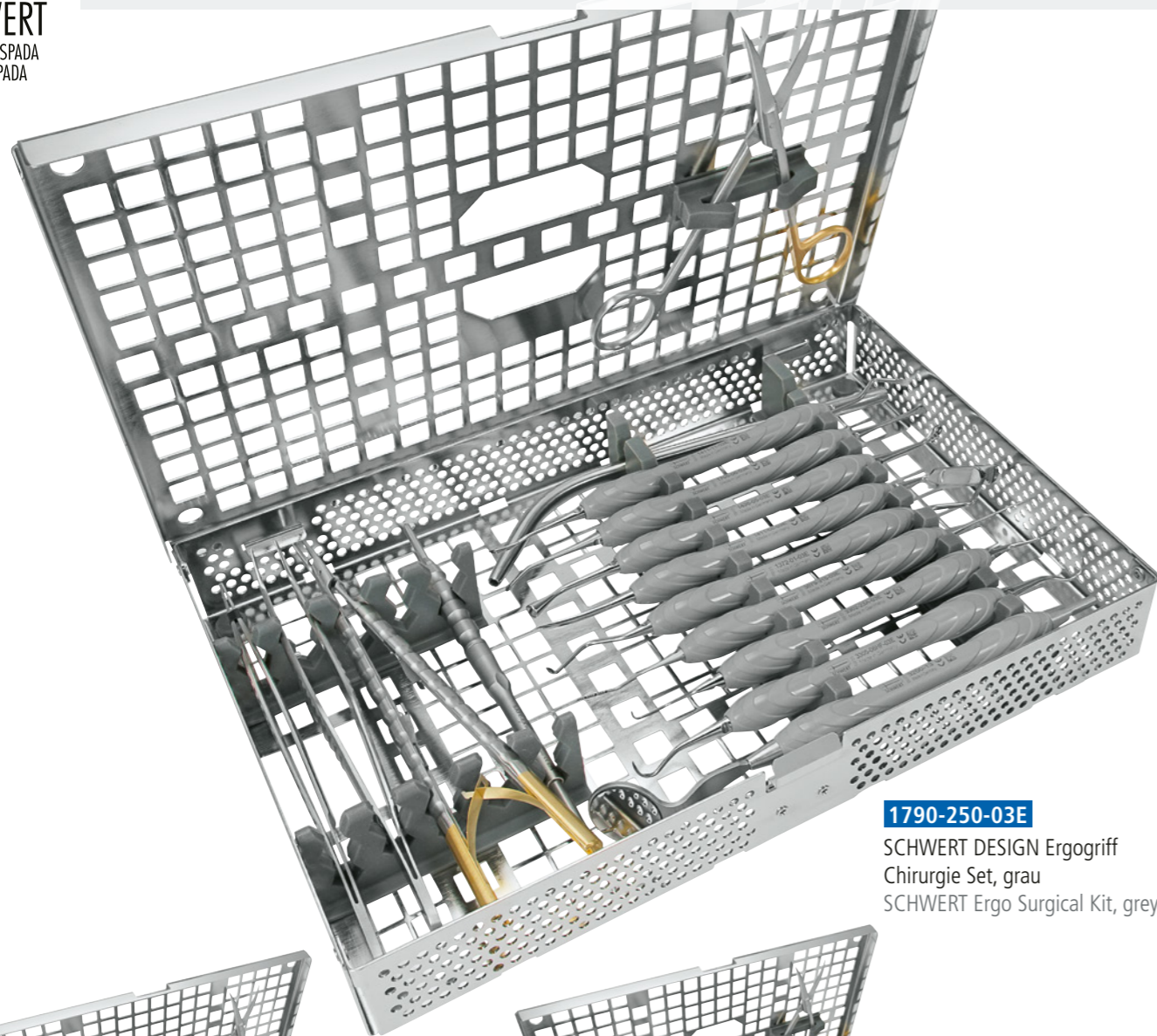

1790-250-03E
SCHWERT DESIGN Ergogriff
Chirurgie Set, grau
SCHWERT Ergo Surgical Kit, grey



1790-250-02E
SCHWERT DESIGN Ergogriff
Chirurgie Set, blau
SCHWERT Ergo Surgical Kit, blue



















1790-250-09E
SCHWERT DESIGN Ergogriff
Chirurgie Set, türkis
SCHWERT Ergo Surgical Kit, turquoise

12.2023

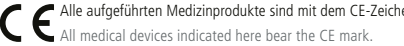

SCHWERT
SWORD · ESPADA
EPEE · SPADA

Artikel-Nr. Item-No.	Artikelbeschreibung Description
	1790-250-03E SCHWERT DESIGN Ergogriff Chirurgie Set mit Ergo Griffen in grau im SCHWERT Protector-Korb 1/1 REF 2603-08 bestehend aus: SCHWERT Ergo Surgical Kit with Ergo handles grey, in Protector-basket 1/1 REF 2603-08 consisting of:
	1411-11-03E Kombi-Instrument Dissektionsspitze M4 x 0,5, Back Action Einsatz 90° Combi instrument, dissector / back action exchangeable, M4 x 0.5
	1411-08-03E Kombi Instrument Prichard Spatel/Raspa, 4 mm Combi Instrument, Prichard spatula/periosteal 4 mm
	1705-06-03E Kombi-Instrument Papillenheber 2,5 mm, Papillmesser 4 mm Combi instrument, papilla elevator 2.5 mm, papilla knife 4 mm
	1436-05-03E Kombinationsinstrument, Stopfer 5 mm, Löffel 6 mm Combi instrument, plugger 5 mm, spoon 6 mm
	1372-01-03E Kombi Instrument, Lucas Kürette 2,5 mm, rechts und links Combi instrument, bone curette Lucas 2.5 mm, right and left
	3302-23A-03E Universal Kürette Fig. M23 A Universal Curette fig. M23 A
	3305-06HF-03E Scaler Hygienist H6/H7, feine Ausführung Scaler Hygienist H6/H7, fine model
	3079-315-03E Parodontometer North Carolina CNC und Sonde Fig. 3A Perio probe North Carolina CNC and probe fig. 3A
	2807-4 + 3200-33 MEGA mouth mirrors plane, double, size 4, 22 mm, Front Surface in SCHWERT Ergo handle grey REF 3200-13
	2000-60 twist TC Mikro Nadelhalter mit Schloss, 17,5 cm twist TC Micro Needle holder with lock, 17.5 cm
	1125-400 JOSEPH  Zahnfleischschere, gebogen, 14 cm JOSEPH  Gum scissors, curved, 14 cm
	1033-61 SAFE-EX 2® Sicherheitsklingenhalter, zerlegbar, 15 cm SAFE-EX 2® Safety blade holder, dismountable, 15 cm
	1208-115 Pinzette MICRO-ADSON, 15 cm, 1 x 2 Zähne, 1,0 mm Forceps MICRO-ADSON, 15 cm, 1 x 2 teeth, 1.0 mm
	2887 COLLEGE Zahnpinzetten, 15 cm, kräftige Figur/Spitzen COLLEGE Tweezers, 15 cm, strong tips
	2564-30 Chirurgischer Absauger, Ø 3,0 mm gebogen, 175 mm, mit Schlitz zum Schutz gegen Festsaugen Ø 6 mm Anschluss Surgical aspiration Ø 3.0 mm, 175 mm, Ø 6 mm connection with additional slot against sucking in

12.2023



2000-66 twist TC

Mikro-Nadelhalter TC-Einsatz, 17,5 cm, Schloss, geschützte Innenfeder, gebogen
Micro Needleholder, TC insert, 17.5 cm, lock, protected inner spring, curved

2000-60 twist TC

Mikro-Nadelhalter, TC-Einsatz, 17,5 cm, Schloss, geschützte Innenfeder, gerade
Micro Needleholder, TC insert, 17.5 cm, lock, protected inner spring, straight

2000-70 twist TC

Mikro-Nadelhalter nach Kirsch, TC-Einsatz, 17,5 cm, Schloss, geschützte Innenfeder, gerade
Micro Needleholder acc. Kirsch, TC insert, 17.5 cm, lock, protected inner spring, straight

Fadenstärke
Suture size



SCHWERT **twist** Serie · series

Neues Design am Schluss für taktiles Öffnen und Schließen ermöglicht noch präziseres Nähen.

New design on the joint for more tactile opening and closing allow more precise suturing.



Foto- und Wangenabhalter
Cheek retractor

Ideal geeignet für hochauflösende Bild- oder Videoaufnahmen bei der Behandlung.

All Perfectly suited for high resolution photo or video shooting during the treatment.



2515-02

Foto- und Wangenabhalter, 1/2 links, 13 cm lang, Breite Abhalter 4,8 cm
Cheek retractor for intraoral photography, 1/2 left sided, 13 cm long, width retractor 4.8 cm

2515-01

Foto- und Wangenabhalter 13 cm lang, Breite Abhalter 5,5 cm
Cheek retractor for intraoral photography, 13 cm long, width retractor 5.5 cm

2515-03

Foto- und Wangenabhalter, 1/2 rechts, 13 cm lang, Breite Abhalter 4,8 cm
Cheek retractor for intraoral photography, 1/2 right sided, 13 cm long, width retractor 4.8 cm

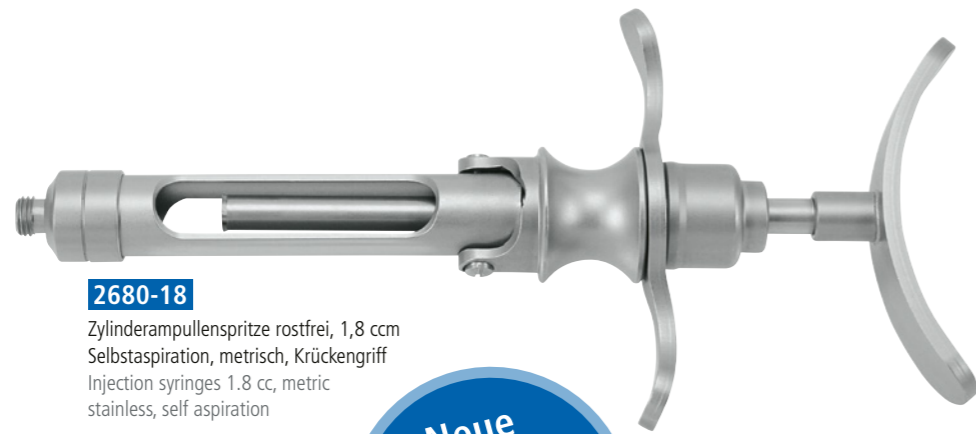

2680-18

Zylinderampullenspritze rostfrei, 1,8 ccm
Selbstaspiration, metrisch, Krückengriff
Injection syringes 1.8 cc, metric
stainless, self aspiration

2680-18US

US-Gewinde
US-thread

Neue Modelle
New models

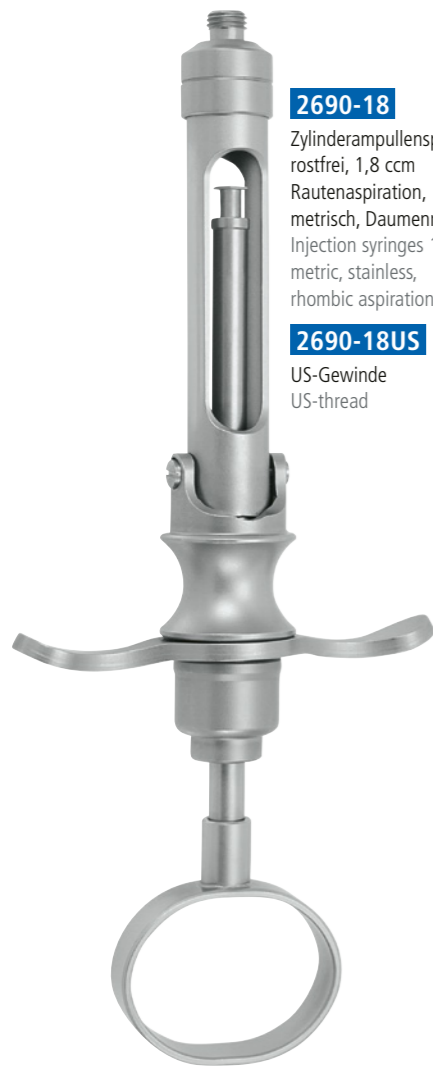

2690-18

Zylinderampullenspritze
rostfrei, 1,8 ccm
Rautenaspiration,
metrisch, Daumenring
Injection syringes 1.8 cc,
metric, stainless,
rhombic aspiration

2690-18US

US-Gewinde
US-thread

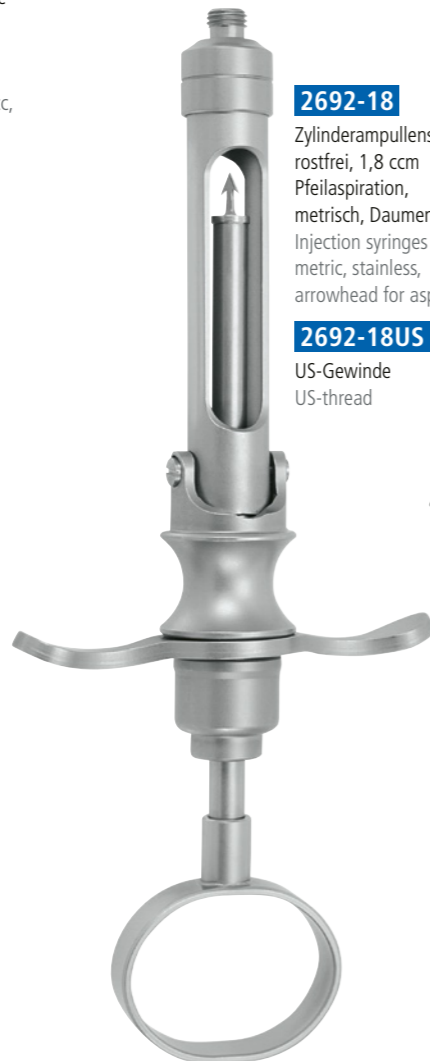

2692-18

Zylinderampullenspritze
rostfrei, 1,8 ccm
Pfeilaspiration,
metrisch, Daumenring
Injection syringes 1.8 cc,
metric, stainless,
arrowhead for aspiration

2692-18US

US-Gewinde
US-thread

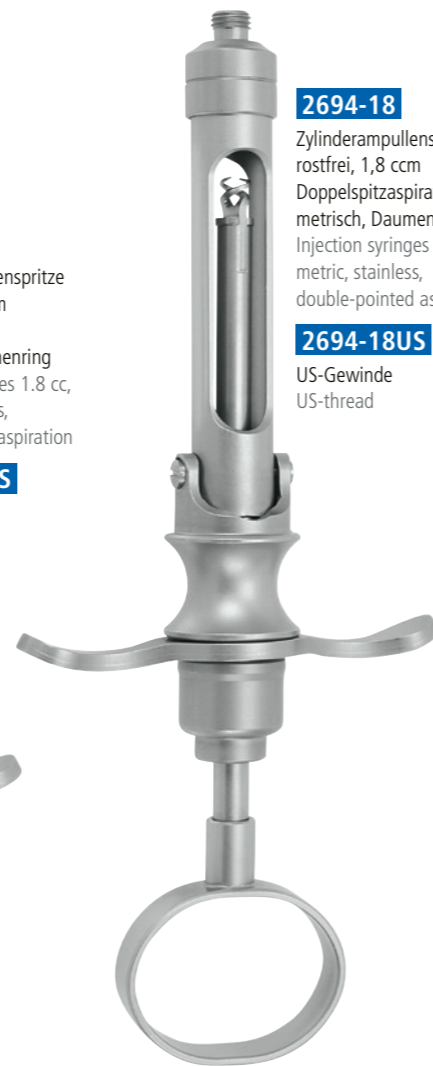

2694-18

Zylinderampullenspritze
rostfrei, 1,8 ccm
Doppelspitzaspiration,
metrisch, Daumenring
Injection syringes 1.8 cc,
metric, stainless,
double-pointed aspiration

2694-18US

US-Gewinde
US-thread



i

Für die Knochen Augmentation perfekt abgestimmte Arbeitenden in drei leichten, farbcodierten Instrumentengriffen.

- 1 Stodger/Löffel Kombinationsinstrument zum Einbringen und Formen des Transplantats.
- 2 Transplantat-Träger mit großem und kleinem Löffel für schnelles und vereinfachtes Einbringen des Transplantats.
- 3 Kugel- und Planstopfer Kombinationsinstrument ermöglicht präzises Einbringen und Verdichten des Transplantats.

Working ends perfectly matched for bone augmentation in three lightweight, color-coded instrument handles.

- 1 Stodger/spoon combination instrument for transplant application and contouring.
- 2 Graft carrier with big and small spoon for fast and easy transplant placing.
- 3 Ball and flat plugger combination allows precise inserting and packing of transplants.

1697-100-00E

Knochen Augmentation Set, beinhaltet:
1697-01-07E, 1697-02-08E, 1697-03-09E,
1697-0Ti-06E, SCHWERT Protector-Tray 2597-08
Bone augmentation kit, consisting of:
1697-01-07E, 1697-02-08E,
1697-03-09E, 1697-0Ti-06E,
SCHWERT Protector-Tray

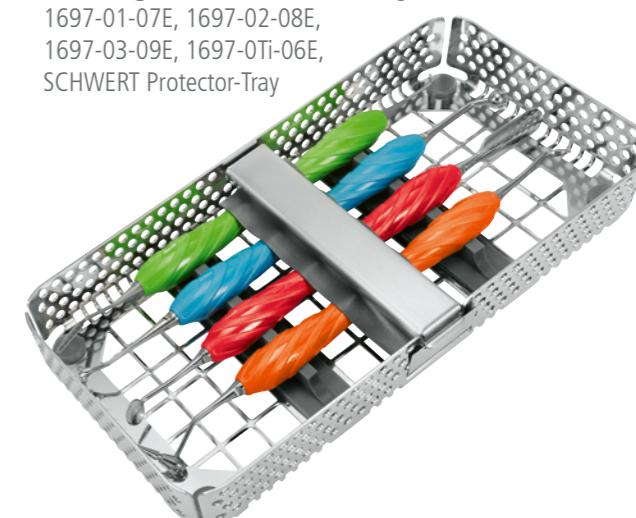

1697-01-07E

Graft Carrier Plugger
SCHWERT Ergo Griff orange
SCHWERT Ergo handle orange

1697-02-08E

Graft Material Carrier
SCHWERT Ergo Griff hellrot-magenta
SCHWERT Ergo handle lightred magenta

1697-03-09E

Graft and Sinus Packer
SCHWERT Ergo Griff türkis-lichtblau
SCHWERT Ergo handle turquoise

1697-0Ti-06E

Titan Knochenstopfer
Bone Condenser with Titanium tips
Graduation 3/6/9/12/15 mm,
Ø 1,0/2,0 mm
SCHWERT Ergo Griff grün
SCHWERT Ergo handle green





SCHWERT
SWORD · ESPADA
EPEE · SPADA

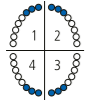

3301-05-05E Für Front- und Eckzähne, gewinkelt
For anterior incisors and canines, angled
GRA 5/6



3301-07-03E Für Prämolaren/Molaren, bukkal/lingual, stärker gewinkelt
For premolars/molars, buccal/lingual, strongly angled
GRA 7/8



3301-11-01E Für Prämolaren/Molaren, alle mesialen Flächen
For all mesial surfaces of premolars/molars
GRA 11/12



3301-13-02E Für Prämolaren/Molaren, alle distalen Flächen
For all distal surfaces of premolars/molars
GRA 13/14

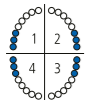

3305-04S-06E Sichel-scaler zur Zahnsteinentfernung der Interdentalräume im Molarenbereich
Sickle scaler for removing dental plaque from interdental spaces in the molar area
204S

3301-100-00E

GRACEY Set, beinhaltet:
GRACEY 5/6, 7/8, 11/12, 13/14, Scaler 204S,
SCHWERT Protector-Tray 2597-05
GRACEY Set, consisting of:
GRACEY 5/6, 7/8, 11/12, 13/14, Scaler 204S,
SCHWERT Protector-Tray 2597-05

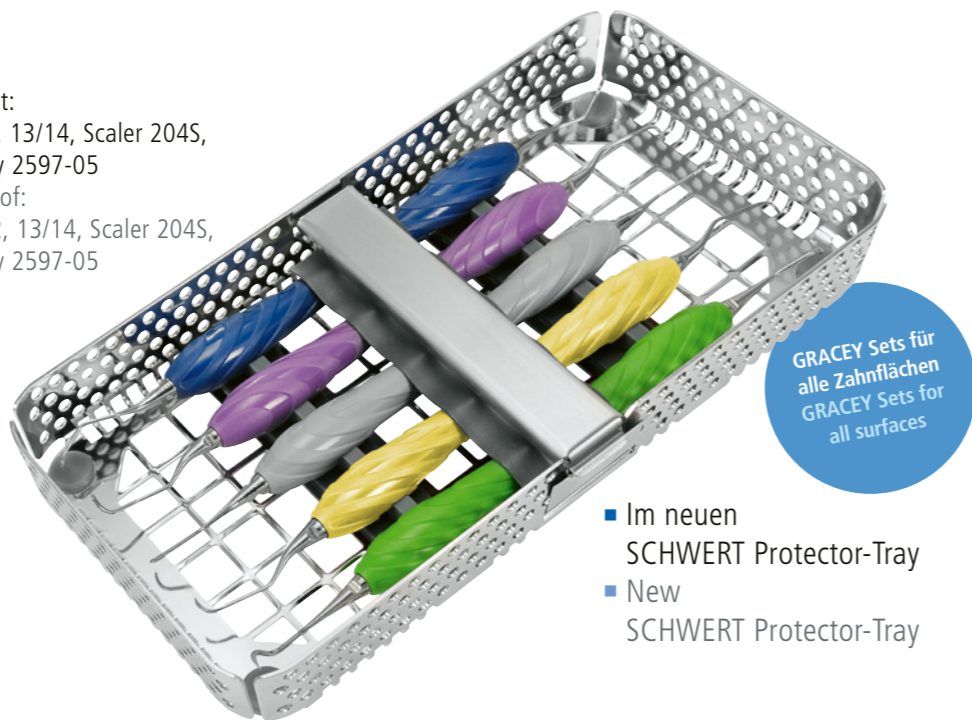

GRACEY Sets für
alle Zahnflächen
GRACEY Sets for
all surfaces

- Im neuen SCHWERT Protector-Tray
- New SCHWERT Protector-Tray



SCHWERT
SWORD · ESPADA
EPEE · SPADA

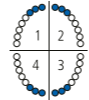

3301-01-05E Für Front- und Eckzähne, leicht gewinkelt
For anterior incisors and canines, slightly angled
GRA 1/2

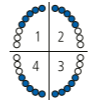

3301-03-05E Für Frontzähne und Prämolaren, leicht gewinkelt
For anterior and premolars, slightly angled
GRA 3/4



3301-09-03E Für Prämolaren/Molaren, bukkal/lingual, sehr stark gewinkelt
For premolars/molars, buccal/lingual, very strongly angled
GRA 9/10

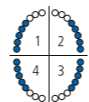

3301-15-01E Für Prämolaren/Molaren, alle mesialen Flächen, entgegengesetzte Schneiden zu 13/14
For premolars/molars, all mesial surfaces, angulation like 13/14, but opposite blades
GRA 15/16

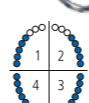

3301-17-02E Für Prämolaren/Molaren, optimaler Zugang im distalen Bereich, für tiefe Taschen
For premolars/molars, for optimal access to distal surfaces and deep pockets
GRA 17/18

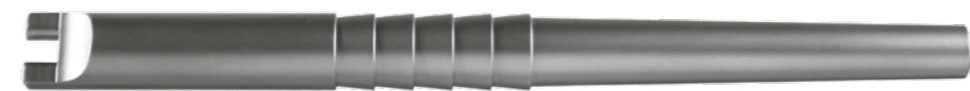

3300-00 Schlüssel zum Auswechseln der Arbeitsenden
Key to exchange working tips

i

Wechsel-Schlüssel · Exchange key

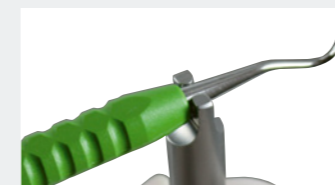

Zum auswechseln der Arbeitsenden, passend für alle ERGO DESIGN Instrumente. **Tip:** Zum Ausrichten der Spitzen empfiehlt es sich, zwei Schlüssel zu verwenden.

For exchanging the working tips, fits for all ERGO DESIGN Instruments. **Tip:** For a parallel adjustment we recommend to use two keys.



SCHWERT
SWORD · ESPADA
EPEE · SPADA

i

GRACEY Mini-Küretten · GRACEY Mini-Curettes

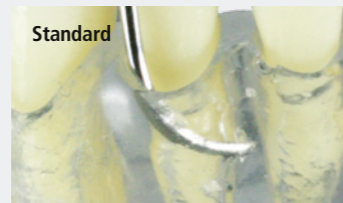

Die SCHWERT Mini-Graceys besitzen im Vergleich zu Standard Gracey Figuren einen um 3 mm längeren 1er Schaft und um 50% verkürzte Arbeitssenden

Compared to standard Gracey figures the SCHWERT Mini-Gracey have a 3 mm longer 1st shaft and a 50% shortened active tip.

They are recommended for:

Besonders geeignet für:

- Enge, tiefe Taschen
- Wurzelglättung
- dünnen parodontalen Biotyp

- deep and narrow pockets
- root planing
- for thin periodontal biotypes

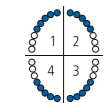

3301-01M5-05E Deep scaling für Frontzähne und Prämolaren, gewinkelt
GRA 1/2M5 Deep scaling for anteriors and premolars, angled

3310-102GM5

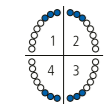

3301-05M5-05E Deep scaling für Front- und Eckzähne, gewinkelt
GRA 5/6M5 Deep scaling for anterior incisors and canines, angled

3310-106GM5

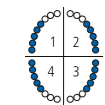

3301-07M5-03E Deep scaling für Prämolaren und Molaren, bukkal/lingual, gewinkelt
GRA 7/8M5 Deep scaling for premolars and molars, buccal/lingual, angled

3310-108GM5



SCHWERT
SWORD · ESPADA
EPEE · SPADA

3301-100M5-00E

GRACEY Mini Set, beinhaltet:
GRACEY 1/2M5, 7/8M5, 11/12M5, 13/14M5,
Scaler 204S, SCHWERT Protector-Tray 2597-05

GRACEY Mini Set, consisting of:
GRACEY 1/2M5, 7/8M5, 11/12M5,
13/14M5, scaler 204S,
SCHWERT Protector-Tray 2597-05

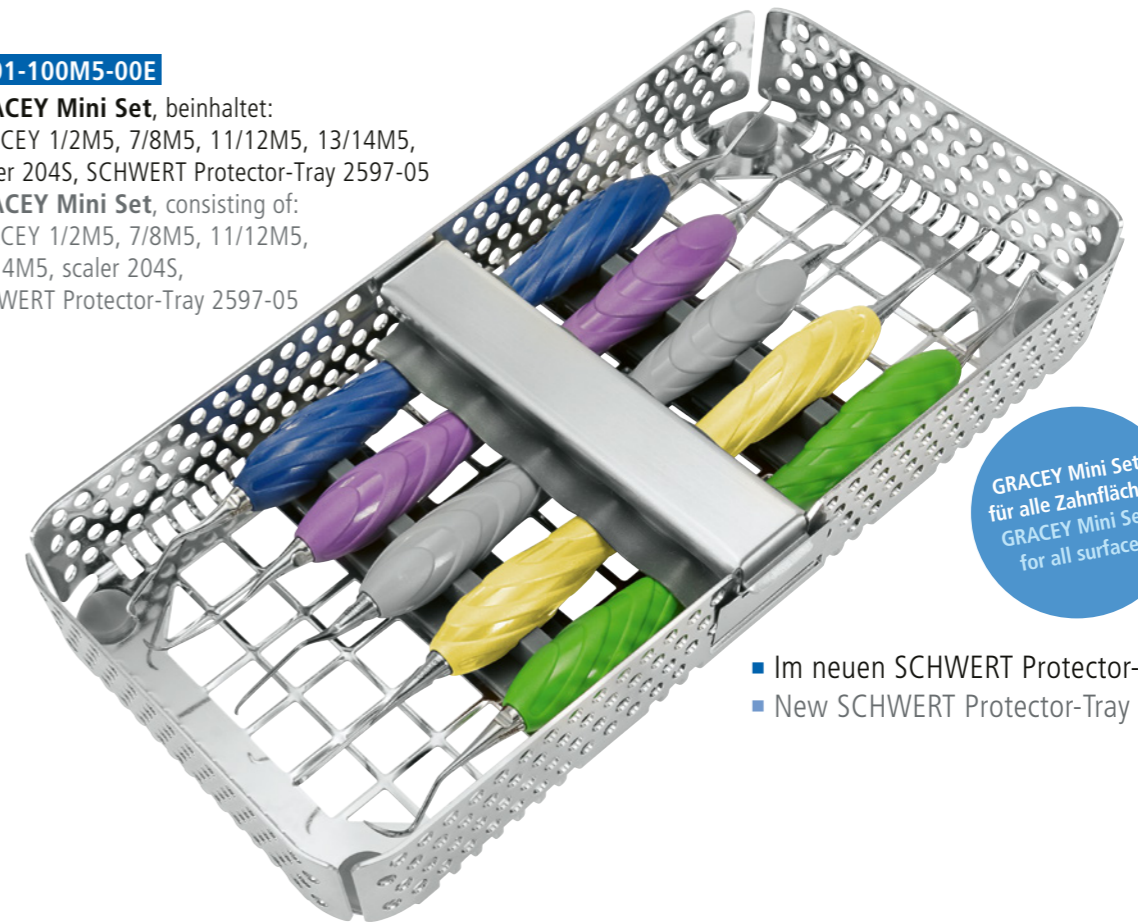

GRACEY Mini Sets
für alle Zahnflächen
GRACEY Mini Sets
for all surfaces

- Im neuen SCHWERT Protector-Tray
- New SCHWERT Protector-Tray

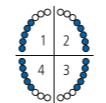

3301-11M5-01E Deep scaling für Prämolaren und Molaren, mesial, doppelt gewinkelt
GRA 11/12M5 Deep scaling for premolars and molars, mesial, double angled

3310-112GM5

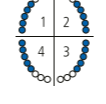

3301-13M5-02E Deep scaling für Prämolaren und Molaren, distal, doppelt gewinkelt
GRA 13/14M5 Deep scaling for premolars and molars, distal, double angled

3310-114GM5

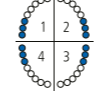

3305-04S-06E Sichel-scaler zur Zahnsteinentfernung der Interdentalräume im Molarenbereich
204S Sickle scaler for removing dental plaque from interdental spaces in the molar area

3310-204R



i

Ti Mini Küretten · Ti Mini curettes

SCHWERT Mini-Gracey Ti Küretten zur Implantatreinigung mit auswechselbaren, sehr grazil ausgearbeiteten Titan-Spitzen, zur Entfernung der angelagerten Plaque-Schichten auf Implantathälsen.

Die Titan-Spitzen sind nachschleifbar.

All purpose implant curettes with exchangeable, very delicate titanium inserts to remove the accumulated plaque film on implant necks.

The titanium inserts are resharpenable.



3310-101GM5-Ti **3301-01M5Ti-05E** GRA1/2 Spezial-Kürette, Gracey, GRA 1/2 M5, Griff gelb, auswechselbare Titanspitzen, 17,5 cm, leicht gewinkelt für OK / UK Frontzähne, für Deep Scaling
Special curette, Gracey, GRA 1/2 M5, yellow handle, exchangeable titanium tips, 17.5 cm, light angled front teeth, lower / upper, for deep scaling



3310-107GM5-Ti **3301-07M5Ti-03E** GRA 7/8 Spezial-Kürette, Gracey, GRA 7/8 M5, Griff grau, auswechselbare Titanspitzen, 17,5 cm, stärker gewinkelt für OK / UK Prämolaren / Molaren, bukkal / lingual, für Deep Scaling
Special curette, Gracey, GRA 7/8 M5, grey handle, exchangeable titanium tips, 17.5 cm, angled for deep scaling, premolars / molar, lower / upper, buccal / lingual, for deep scaling



3310-111GM5-Ti **3301-11M5Ti-01E** GRA 11/12 Spezial-Kürette, Gracey, GRA 11/12 M5, Griff violett, auswechselbare Titanspitzen, 17,5 cm, doppelt gewinkelt, für OK / UK Prämolaren / Molaren, mesiale Flächen, für Deep Scaling
Special curette, Gracey, GRA 11/12 M5, purple handle, exchangeable titanium tips, 17.5 cm, double angled, for deep scaling, lower / upper, molars / premolars, mesial areas, for deep scaling



3310-113GM5-Ti **3301-13M5Ti-02E** GRA 13/14 Spezial-Kürette, Gracey, GRA 13/14 M5, Griff blau, auswechselbare Titanspitzen, 17,5 cm, doppelt gewinkelt für OK / UK, Prämolaren / Molaren, distale Flächen, für Deep Scaling
Special curette, Gracey, GRA 13/14 M5, blue handle, exchangeable titanium tips, 17.5 cm, double angled for molars / pre molars, lower / upper, distal area, for deep scaling

3301-100M5Ti-00E

Gracey Set M5 mit Titanspitzen
Gracey Set M5 with titanium tips

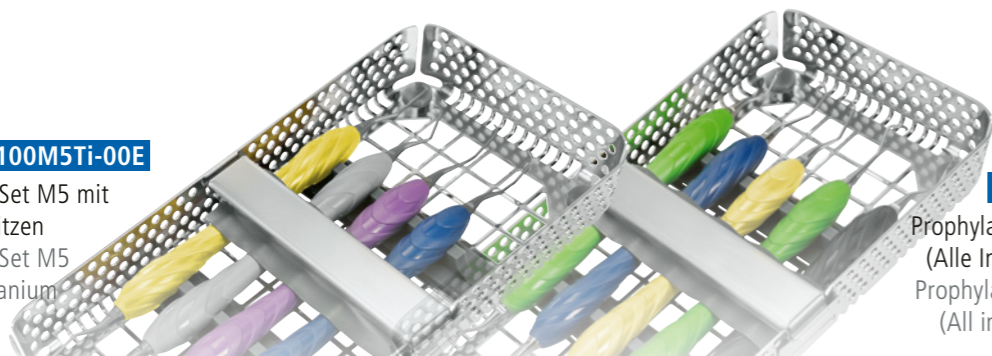

3303-100-00E

Prophylaxe Set Universal (Alle Instrumente S.19)
Prophylaxe Kit Universal (All instruments P.19)

i

Langer Standard Ausführung · Langer Standard version

Im Gegensatz zu den Gracey Küretten haben Universal-Küretten zwei Arbeits- bzw. Schneidkanten, so dass Konkremete am Zahnhals sowie entzündetes Gewebe in den Taschen gleichzeitig in einem Schritt entfernt werden können. Mit den drei Figuren (Langer 1/2, 3/4 und 5/6) kann die Prophylaxebehandlung an allen Quadranten effizient erfolgen.

Unlike Gracey curettes, universal curettes have two working surfaces / cutting edges, so that concretions on the tooth neck as well as inflamed tissue in the pockets can be removed simultaneously in one step. The three instruments (Langer fig. 1/2, 3/4 and 5/6) allow an efficient prophylaxis treatment in all quadrants.



3310-101L **3303-01-04E** L 1/2 LANGER L 1/2, Universal Kürette, für Unterkiefer Prämolaren / Molaren
LANGER L 1/2, universal curette, for mandibular posterior



3310-103L **3303-03-06E** L 3/4 LANGER L 3/4, Universal Kürette, für Oberkiefer Prämolaren / Molaren
LANGER L 3/4, universal curette, for maxillary posterior



3310-105L **3303-05-05E** L 5/6 LANGER L 5/6, Universal Kürette, für Oberkiefer / Unterkiefer Frontzähne
LANGER L 5/6, universal curette, for maxillary and mandibular anterior



3310-123L **3302-23A-02E** M23A Universal Kürette M 23A, für Ober- / Unterkiefer, supragingivalen Zahnstein, grazile Ausführung
Universal curette M 23A, for upper and lower jaw teeth and supragingival calculus, slim



3310-204L **3305-04S-06E** 204S Sichelscaler zur Zahnsteinentfernung der Interdentalräume im Molarenbereich
Sickle scaler for removing dental plaque from interdental spaces in the molar area





SCHWERT
SWORD · ESPADA
EPEE · SPADA

i

Langer M5 Ausführung · Langer M5 version

Die neuen SCHWERT Langer M5 Universal-Küretten sind speziell zum Deep Scaling – zum Entfernen von Ablagerungen an Zahn- bzw. Wurzeloberflächen und gleichzeitigem Entfernen von entzündetem Gewebe geeignet. Aufgrund der beidseitig geschliffenen Arbeitsenden finden die M5 Langer besonders bei sehr tiefen Taschen – bei der geschlossenen Parodontose-Behandlung – ihren Einsatz.

The new SCHWERT Langer M5 universal cures are especially suitable for deep scaling – for removing deposits on tooth or root surfaces and simultaneously removing inflamed tissue. Due to the ground working end on both sides, the M5 Langer cures are used especially for very deep pockets – in the closed periodontosis treatment.

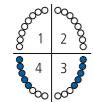

3303-01M5-04E

L 1/2

Langer, # L 1/2, M5 Kürette, Ø 0,95, für Unterkiefer-Molaren und -Prämolaren
Langer, # L 1/2, M5 curette, Ø 0.95, for use on lower molars and premolars

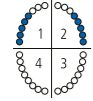

3303-03M5-06E

L 1/2

Langer, # L 3/4, M5 Kürette, Ø 0,95, für Oberkiefer-Molaren und -Prämolaren, gelbgrün
Langer, # L 3/4, M5 curette, Ø 0.95, for use on upper molars and premolars



3303-05M5-05E

L 5/6

Langer, # L 5/6, M5 Kürette, Ø 0,95, für den Frontzahnbereich, gelb
Langer, # L 5/6, M5 curette, Ø 0.95, for use on upper and lower front teeth, yellow

i

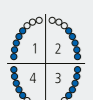

3303-17-02E

L 17/18

Langer, # L 17/18, Spezial-Kürette, Ø 1,05, für Molaren und -Prämolaren OK/UK, blau
Langer, # L 17/18, special curette, Ø 1.05, for use on molars and premolars, maxillary/mandibular, blue

Die neue Langer Kürette # L 17/18 verfügt über die gleiche Biegung wie die Gracey # GRA 17/18 und ist die perfekte Ergänzung zu unserem Universal-Küretten Sortiment. Die 3-fach-Biegung der Arbeitsenden ermöglicht einen optimalen Zugang speziell im distalen Prämolaren- und Molarenbereich sowie bei eingeschränkter Mundöffnung.

The new Langer Curette # L 17/18 has the same bending as the Gracey # GRA 17/18 and thus is the perfect complement to our range of Universal Curettes. The triple bend of the working ends provides optimal access, especially in the distal premolar and molar area and even when mouth opening is restricted.

i

Langer Titan-Küretten

Die Langer Küretten mit auswechselbaren Titan-Einsätzen eignen sich hervorragend zur Entfernung von angelagerten Plaqueschichten auf den Implantat-hälsen. Durch das Titan-Material wird die Oberfläche des Implantates nicht beschädigt.

Langer titanium cures

The Langer cures with exchangeable titanium inserts are ideal for removing attached plaque layers on the implant necks. The titanium material does not damage the surface of the implant.

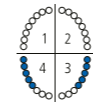

3303-01Ti-04E

L 1/2

Langer, # L 1/2, Universal-Kürette mit Titan-Einsätzen, Ø 1,05, für Unterkiefer-Molaren und -Prämolaren, schwarz
Langer, # L 1/2, universal curette with titanium inserts, Ø 1.05, for use on lower molars and premolars, black

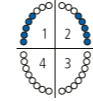

3303-03Ti-06E

L 3/4

Langer, # L 3/4, Universal-Kürette mit Titan-Einsätzen, Ø 1,05, für Oberkiefer-Molaren und -Prämolaren, gelbgrün
Langer, # L 3/4, universal curette with titanium inserts, Ø 1.05, for use on upper molars and premolars, yellowgre.



3303-05Ti-05E

L 5/6

Langer, # L 5/6, Universal-Kürette mit Titan-Einsätzen, Ø 1,05, für den Frontzahnbereich, gelb
Langer, # L 5/6, universal curette with titanium inserts, Ø 1.05, for use on upper and lower front teeth, yellow

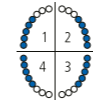

3302-04Ti-02E

CU 4R/4L

COLUMBIA UNIVERSITY 4R/4L, Universal Kürette, Titan Spitzen, für Oberkiefer/Unterkiefer Prämolaren/Molaren
COLUMBIA UNIVERSITY 4R/4L, universal curette, titanium tips, for maxillary and mandibular posterior



SCHWERT
SWORD · ESPADA
EPEE · SPADA



i

Langer, feine Ausführung · Langer, delicate version

Analog zu den Standard Langer Universal-Küretten haben auch die feinen Ausführungen zwei Arbeits- bzw. Schneidkanten, sodass Konkremente am Zahnhals sowie entzündetes Gewebe in den Taschen gleichzeitig in einem Schritt entfernt werden können. Durch den 0,95 mm dünnen, flexiblen und somit taktilen 1er-Schaft adaptieren sie optimal an den Zahnhälsen.

Analogous to the standard Langer universal cures, the delicate versions also have two working or cutting edges, so that concretions on the tooth neck and inflamed tissue in the pockets can be removed simultaneously in one step. Due to the 0.95 mm thin, flexible and thus tactile 1st shaft, they adapt optimally to the tooth necks.

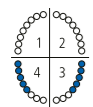

3303-01LF-04E Langer, # L 1/2, Universal-Kürette, feine Ausführung, Ø 0,95, für Unterkiefer-Molaren u. -Prämolaren, schwarz L 1/2 Langer, # L 1/2, universal curette, delicate version, Ø 0.95, for use on lower molars and premolars, black

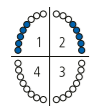

3303-03LF-06E Langer, # L 3/4, Universal-Kürette, feine Ausführung, Ø 0,95, für Oberkiefer-Molaren u. -Prämolaren, gelbgrün L 3/4 Langer, # L 3/4, universal curette, delicate version, Ø 0.95, for use on upper molars and premolars, yellow-green

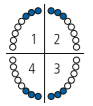

3303-05LF-05E Langer, # L 5/6, Universal-Kürette, feine Ausführung, Ø 0,95, für den Frontzahnbereich, gelb L 5/6 Langer, # L 5/6, universal curette, delicate version, Ø 0.95, for use on upper and lower front teeth, yellow

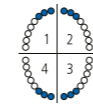

3302-02-02E COLUMBIA UNIVERSITY 2R/2L, für Frontzähne CU 2R/2L COLUMBIA UNIVERSITY 2R/2L, for front teeth

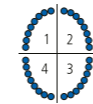

3302-13CU-02E COLUMBIA UNIVERSITY 13/14, Universal Kürette, besonders für Wurzelglättung CU 13/14 COLUMBIA UNIVERSITY 13/14, universal curette, especially for root planing

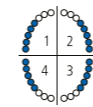

3302-04-02E COLUMBIA UNIVERSITY 4R/4L, Universal Kürette, für Oberkiefer/Unterkiefer Prämolaren/Molaren CU 4R/4L COLUMBIA UNIVERSITY 4R/4L, universal curette, for maxillary and mandibular posterior

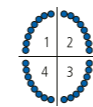

3302-13-02E MCCALL 13S/14S, Universal Scaler, für approximal der Frontzähne und Prämolaren, filigrane, spitze Arbeitsenden MC 13S/14S MCCALL 13S/14S, universal scaler, for interdental spaces of front teeth and premolars, fine, sharply pointed tips

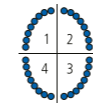

3302-17-02E MCCALL 17S/18S, Universal Scaler, für Molaren, filigrane, runde Arbeitsenden MC 17S/18S MCCALL 17S/18S, universal scaler for molars, fine, rounded tips





SCHWERT
SWORD · ESPADA
EPEE · SPADA

i

M23 Scaler

Die universellen und grazilen Biegungen der Arbeitsenden unseres SCHWERT M23 Scalers, erlauben eine perfekte Zahnsteinentfernung aller supragingivalen Flächen und Interdentalräume.

M23 Scaler

The universal and delicate working tips of our SCHWERT M23 scaler, allow perfect scaling of all supragingival surfaces and all interdental spaces.

3310-123AL  3310-123AR

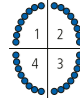
 **3305-23-06E** Universal Sichel scaler zur Zahnsteinentfernung der Interdentalräume
M23 Universal sickle scaler for removing calculus from interdental spaces

3310-204L  3310-204R

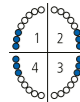
 **3305-04S-06E** Sichel scaler zur Zahnsteinentfernung der Interdentalräume im Molarenbereich
204S Sickle scaler for removing dental plaque from interdental spaces in the molar area

3310-204LD  3310-204RD

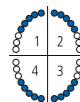
 **3305-04SD-06E** Sichel scaler zur Zahnsteinentfernung schmaler Interdentalräume im Bereich der Prämolaren und Frontzähne.
204SD Sickle scaler for removing dental plaque from narrow interdental spaces in the premolar and frontal area.

3310-107H  3310-106H

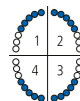
 **3305-06-06E** HYGIENIST Sichel scaler mit Kontrawinkel, für Frontzähne und Prämolaren, mesial/distal
H 6/7 HYGIENIST sickle scaler with opposed tips, for anterior and premolars, mesial/distal

3310-133J  3310-105H

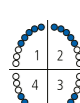
 **3305-533-06E** HYGIENIST/JACQUETTE Scaler 5/33, für Frontzähne und Prämolaren, speziell zur Entfernung von starkem Zahnstein
H5/33 HYGIENIST/JACQUETTE Scaler 5/33, for anterior and premolars, especially for heavy calculus

3310-102CI  3310-103CI

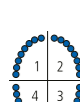
 **3305-02-06E** Kaplan Sichel scaler mit großer, der Zahnkontur angepasster Fazialfläche. Zum Entfernen von starkem Zahnstein, Kunststoff-, Zement- und Klebstoffrückständen in allen Interdentalräumen
CI 2/3 KAPLAN sickle scaler with large facial surfaces matched to tooth contours for removing heavy calculus, plastic, cement, or adhesive residues from all interdental spaces



SCHWERT
SWORD · ESPADA
EPEE · SPADA

3310-135UL  3310-135UR

 **3305-35-06E** Scaler mit kleiner, der Zahnkontur angepasster Fazialfläche, für alle Interdentalräume
U135 Scaler with small facial surfaces matched to tooth contours, for all interdental spaces

3310-102TA  3310-103TA

 **3306-02-06E** TAYLOR mittelgroßer Sichel scaler, der Zahnkontur angepasster Fazialfläche, für alle Interdentalräume
T2/3 TAYLOR medium-sized scaler with facial surfaces matched to tooth contours, for all interdental spaces

3310-104XL  3310-104XR

 **3305-GX-03E** Universal Sichelkurette (Scaler), abgerundeten Spitzen
GXC4 Universal sickle curette (scaler), rounded tips

i

Ti Scaler · Ti Scaler

SCHWERT Ti Scaler zur Implantatreinigung mit auswechselbaren, sehr grazil ausgearbeiteten Titan-Spitzen, zur Entfernung der angelagerten Plaque-Schichten auf Implantathälsen. **Die Titan-Spitzen sind nachschleifbar.**

All purpose implant scaler with exchangeable, very delicate titanium inserts to remove the accumulated plaque film on implant necks. **The titanium inserts are resharpenable.**



3310-204LTi  3310-204RTi

 **3305-04STi-06E** Sichel scaler zur Zahnsteinentfernung der Interdentalräume im Molarenbereich, Titan
S 204 Sickle scaler for removing dental plaque from interdental spaces in the molar area, titanium tips

3310-106HTi  3310-107HTi

 **3305-06Ti-06E** HYGIENIST Sichel scaler mit Kontrawinkel, für Frontzähne und Prämolaren, mesial / distal, Titan
H 6/7 HYGIENIST sickle scaler with opposed tips, for anterior and premolars, mesial / distal, titanium tips



SCHWERT
SWORD · ESPADA
EPEE · SPADA

i

ULTRA Komposite

Die schwarze ULTRA Beschichtung ist im Vergleich zu Standardinstrumenten extrem hart und kratzbeständig. Die blendfreie und glatte Oberflächenstruktur verhindert störende Lichtreflexionen und ein Anhaften von Compositen. Die chemischen Eigenschaften der Beschichtung führen bei der Anwendung von Lösungsmitteln oder Sterilisation zu keinen unerwünschten Reaktionen.

Mit den superfeinen **ULTRA Composite Spateln (4085-09Ti & 4085-10Ti)** hat man sehr feine und hoch flexible Spatel entwickelt. Diese werden insbesondere geschätzt für die anspruchsvolle Arbeit in der ästhetischen Frontzahnzone.

ULTRA composite

The black ULTRA coating is extremely hard and scratch resistant compared to standard instruments. The smooth and anti glare surface avoids disturbing reflections of light and is less sticky for composite materials. The coating does not react with cleaning solutions or throughout the sterilization process, due to its chemical characteristics.

With the super fine **ULTRA composite spatulas (4085-09Ti & 4085-10Ti)** we invented very fine and high flexibles spatulas. They are appreciated particularly for the challenging work in the aesthetic front teeth area.



4085-01Ti-06E Komposite Spatel FIG. 1, fein, 1,8 / 1,5 mm, auswechselbar
Composite spatula FIG. 1, fine, 1.8 / 1.5 mm, exchangeable



4085-02Ti-06E Komposite Spatel FIG. 2, groß, 2,9 / 2,7 mm, auswechselbar
Composite spatula FIG. 2, large, 2.9 / 2.7 mm, exchangeable



4085-03Ti-06E Komposite Birnenstopfer, Ø 1,5 / 2,0 mm, auswechselbar
Composite pear shape plugger, Ø 1.5 / 2.0 mm, exchangeable



4085-04Ti-06E Komposite Fissureninstrument, Ø 1,8 / 1,8 mm, auswechselbar, ein Ende speziell für distal anguliert
Composite occlusal former / burnisher, Ø 1.8 / 1.8 mm, exchangeable, one tip angulated especially for distal



4085-05Ti-06E Komposite Kugelstopfer, fein, Ø 0,9 / 1,3 mm, auswechselbar
Composite ball plugger, fine, Ø 0.9 / 1.3 mm, exchangeable



4085-06Ti-06E Komposite Kugelstopfer, Ø 2,1 / 1,3 mm plan, auswechselbar
Composite ball plugger, Ø 2.1 / 1.3 mm flat, exchangeable



SCHWERT
SWORD · ESPADA
EPEE · SPADA

4085-00Ti-06E

ULTRA Komposite Set, beinhaltet:

4085-01Ti-06E, 4085-02Ti-06E,
4085-03Ti-06E, 4085-04Ti-06E,
SCHWERT Protector-Tray 2597-05

ULTRA Composite set, consisting of:

4085-01Ti-06E, 4085-02Ti-06E,
4085-03Ti-06E, 4085-04Ti-06E,
SCHWERT Protector-Tray
2597-05

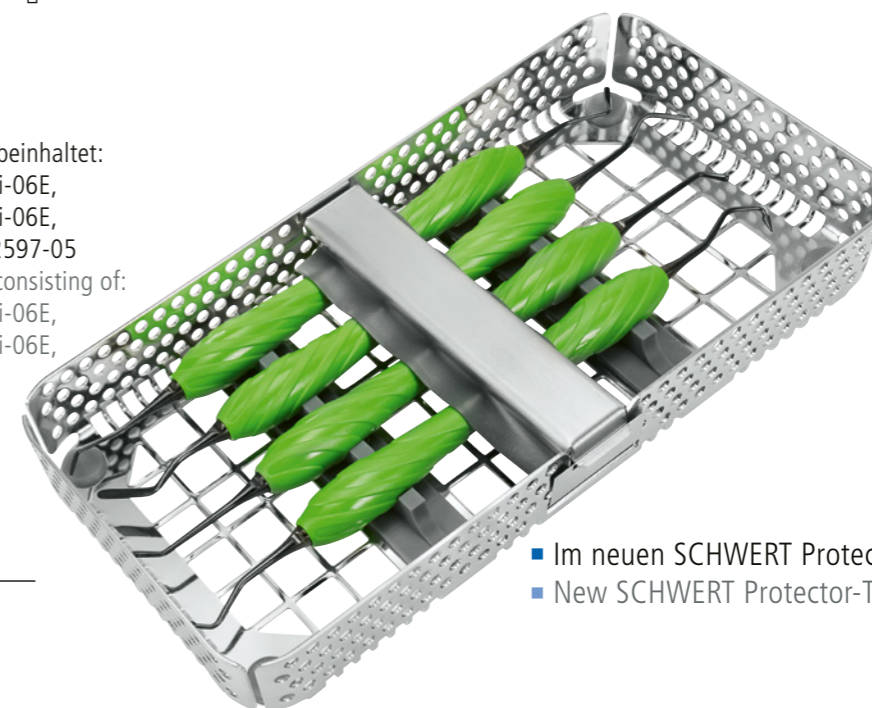

ULTRA

- Im neuen SCHWERT Protector-Tray
- New SCHWERT Protector-Tray



4085-07Ti-06E Komposite Planstopfer, Ø 1,6 / 2,5 mm, auswechselbar
Composite plugger, Ø 1.6 / 2.5 mm, exchangeable



4085-08Ti-06E Komposite Spatel, 1,7 / 1,7 mm, auswechselbar, für interproximal mesial / distal
Composite spatula, 1.7 / 1.7 mm, exchangeable, especially interproximal mesial / distal



4085-09Ti-06E Komposite Spatel, 1,0 mm, sehr fein, flexibel
Composite spatula, 1.0 mm, very fine, flexible



4085-10Ti-06E Komposite Spatel, 1,4 mm, sehr fein, flexibel
Composite spatula, 1.4 mm, very fine, flexible



4085-11Ti-06E Komposite, feiner Spatel FIG. 1, 1,5mm / Birnenstopfer 1,5mm, Universalkombination
Composite, fine spatula FIG. 1, 1.5mm / pear shape plugger 1.5mm, universal combination



4085-12Ti-06E Komposite Fissurenzieher, Ø 1,8 / 2,2 mm
Composite cone burnisher, Ø 1.8 / 2.2 mm



SCHWERT
SWORD · ESPADA
EPEE · SPADA



3635-1-03E Mikrosonde, doppelendig, Arbeitsende 45° / 90°
Micro probe, double ended, working tips 45° / 90°



3635-2-05E Retro Instrument, Kugel Ø 1,5 mm, Spatel gerade
Retro instrument, ball Ø 1.5 mm, straight spatula



3635-3-05E Retro Instrument, Kugel Ø 1,5 mm, Spatel gebogen
Retro instrument, ball Ø 1.5 mm, curved spatula



3635-4-05E Retro Instrument mikro, Kugel Ø 0,8 / Stopfer Ø 0,5 mm, 130° gewinkelt
Retro instrument micro, ball plugger Ø 0.8 / plugger Ø 0.5 mm, 130° angulated



3635-5-05E Retro Instrument mikro, Kugel Ø 0,8 / Stopfer Ø 0,5 mm, 130° gewinkelt
Retro instrument micro, ball plugger Ø 0.8 / plugger Ø 0.5 mm, 130° angulated



3635-6-02E Retro Instrument mikro, Kugel Ø 0,8 / Stopfer Ø 0,5 mm, 65° gewinkelt
Retro instrument micro, ball plugger Ø 0.8 / plugger Ø 0.5 mm, 65° angulated



3305-45-03E Mini Scaler doppelendig, Arbeitsenden 45° / 90°
Mini scaler double ended, working tips 45° / 90°



3465-14-02E Exkavator chirurgisch, doppelendig, gewinkelt 1,4 mm, flach
Surgical excavator, double ended, 1.4 mm, flat



3465-12-02E Exkavator chirurgisch, doppelendig, gewinkelt 1,2 mm, rund
Surgical excavator, double ended, 1.2 mm, round



SCHWERT
SWORD · ESPADA
EPEE · SPADA

i

Provisorienabnehmer · Temporary crown remover

Kurze, sichelförmige Arbeitsenden ermöglichen eine direkte Übertragung der Zugkraft am Provisorium. Die Arbeitsenden können sicher am Kronenrand adaptiert werden, wodurch ein Abgleiten nahezu vermieden werden kann.

Short sickle shaped working tips allow direct power transmission on temporary crowns. Working tips can be placed safely on the crown's edges, which avoids slipping away professionally.



4931-06E

Provisorienabnehmer,
grün, auswechselbar
Temporary crown remover,
green, exchangeable





SCHWERT
SWORD · ESPADA
EPEE · SPADA

i

Retraktionsfadenstopfer

Um Retraktionsfäden optimal platzieren zu können.

- Je ein Instrument speziell für bukkal / lingual bzw. mesial / distal
- Speziell gebogene und flexible Arbeitsenden, konkav ausgeformt für optimale Anpassung
- Durch mikroverzahnte Arbeitsenden wird ein Abrutschen des Fadens vermieden



Retraction cord packers

To place retraction cords fast and easy.

- One instrument for buccal / lingual and one for mesial / distal
- Special bended and flexible active parts, concave for perfect adaption
- Micro serrated tips for a perfect grip

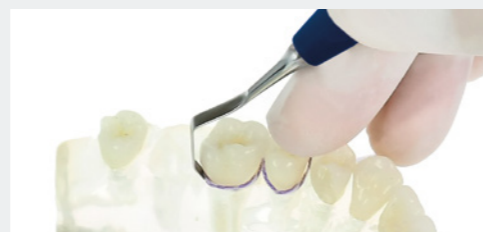

4881-1-06E Retraktionsfadenstopfer bukkal / lingual, grün, auswechselbar
Retraction cord packer buccal / lingual, green, exchangeable



4881-2-02E Retraktionsfadenstopfer distal / mesial, blau, auswechselbar
Retraction cord packer distal / mesial, blue, exchangeable



4881-3-05E Retraktionsfadenstopfer, universal, 45° gewinkelt, gezahnte Arbeitsenden, gelb, auswechselbar
Retraction cord packer, universal, 45° angulated, serrated working tips, yellow, exchangeable



4881-4-03E Retraktionsfadenstopfer, rund, gezahnt, grau, auswechselbar
Retraction cord packer, round, serrated, grey, exchangeable

Neues Design
New design

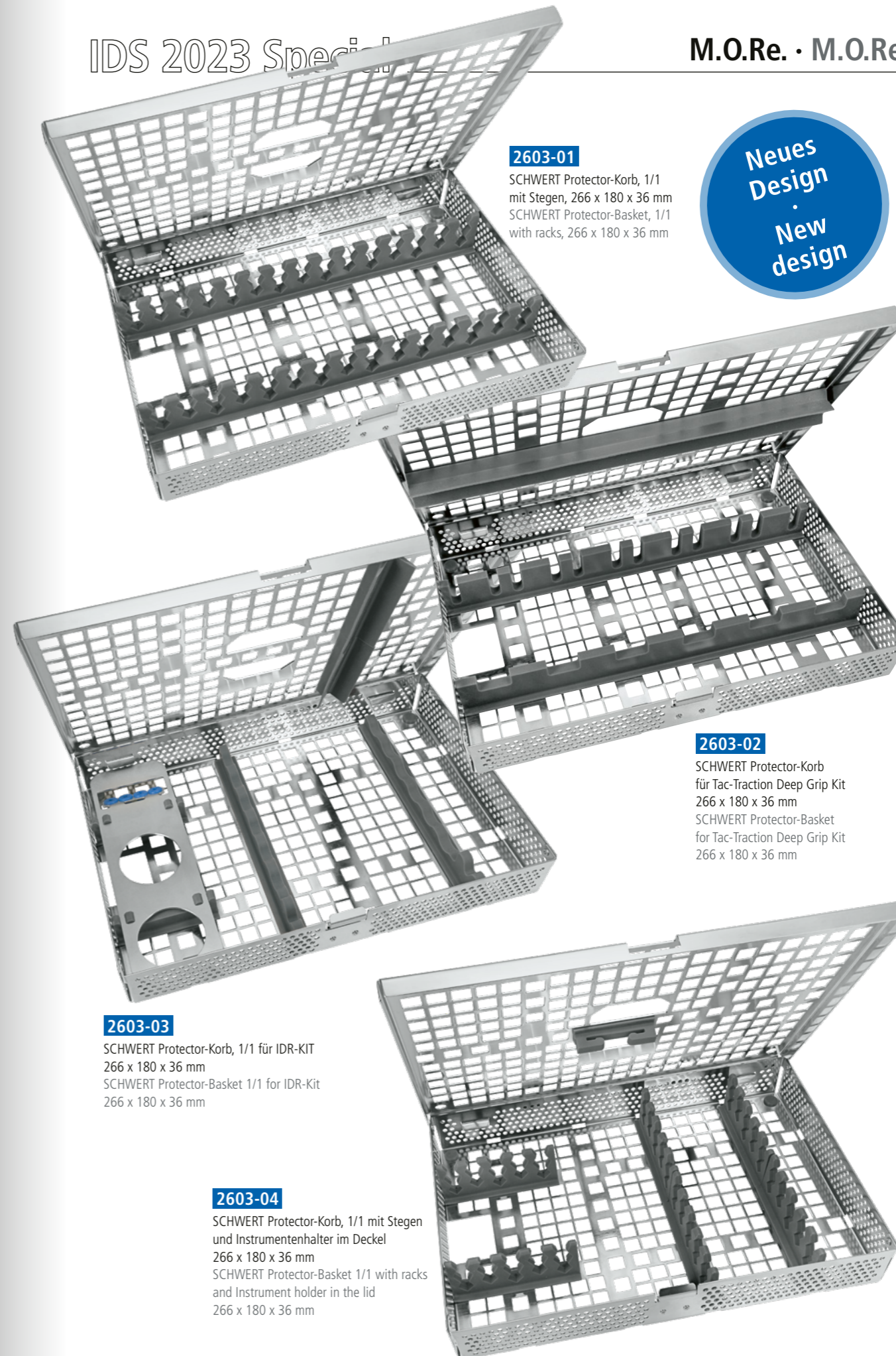

2603-01
SCHWERT Protector-Korb, 1/1 mit Stegen, 266 x 180 x 36 mm
SCHWERT Protector-Basket, 1/1 with racks, 266 x 180 x 36 mm

2603-02
SCHWERT Protector-Korb für Tac-Traction Deep Grip Kit
266 x 180 x 36 mm
SCHWERT Protector-Basket for Tac-Traction Deep Grip Kit
266 x 180 x 36 mm

2603-03
SCHWERT Protector-Korb, 1/1 für IDR-KIT
266 x 180 x 36 mm
SCHWERT Protector-Basket 1/1 for IDR-Kit
266 x 180 x 36 mm

2603-04
SCHWERT Protector-Korb, 1/1 mit Stegen und Instrumentenhalter im Deckel
266 x 180 x 36 mm
SCHWERT Protector-Basket 1/1 with racks and Instrument holder in the lid
266 x 180 x 36 mm



SCHWERT
SWORD · ESPADA
EPEE · SPADA



SCHWERT
SWORD · ESPADA
EPEE · SPADA

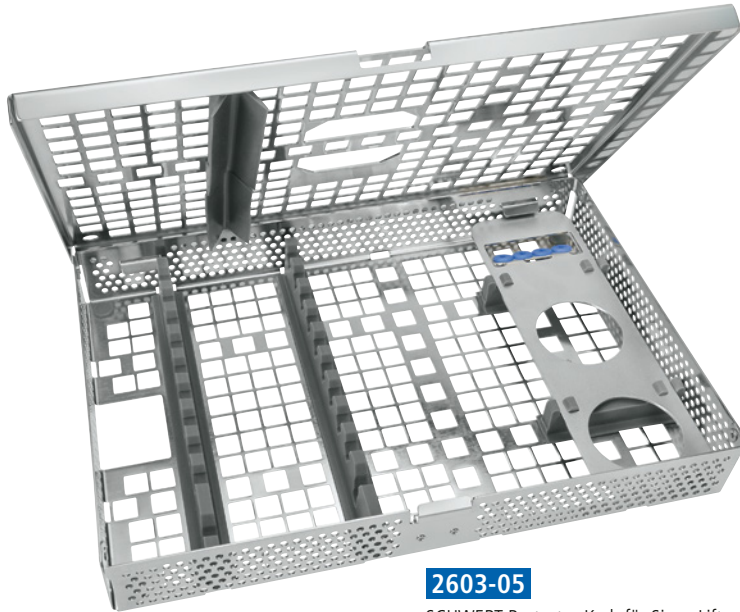

2603-05

SCHWERT Protector-Korb für Sinus-Lift
oder andere sehr lange Instrumente
266 x 180 x 36 mm
SCHWERT Protector-Basket for Sinus
or other long instruments
266 x 180 x 36 mm

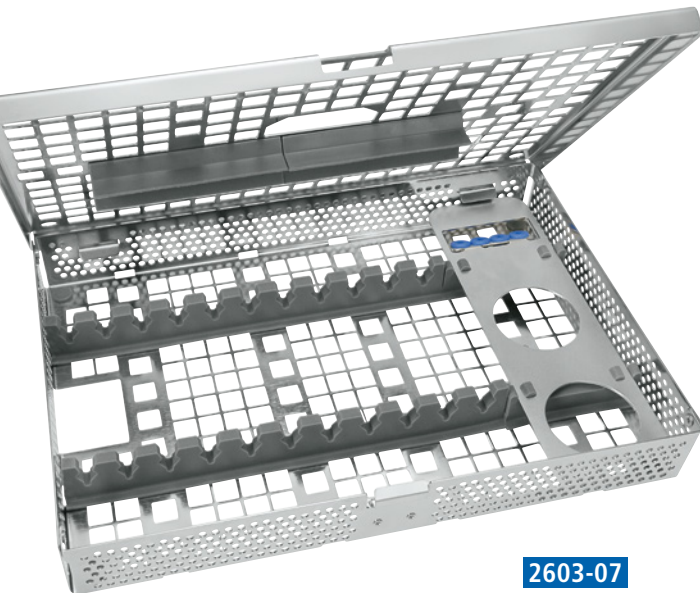

2603-06

SCHWERT Protector-Korb quer für 11
Instrumente mit Einlegeblech für Becher
266 x 180 x 36 mm
SCHWERT Protector-Basket for 11 instruments
with part for cups
266 x 180 x 36 mm

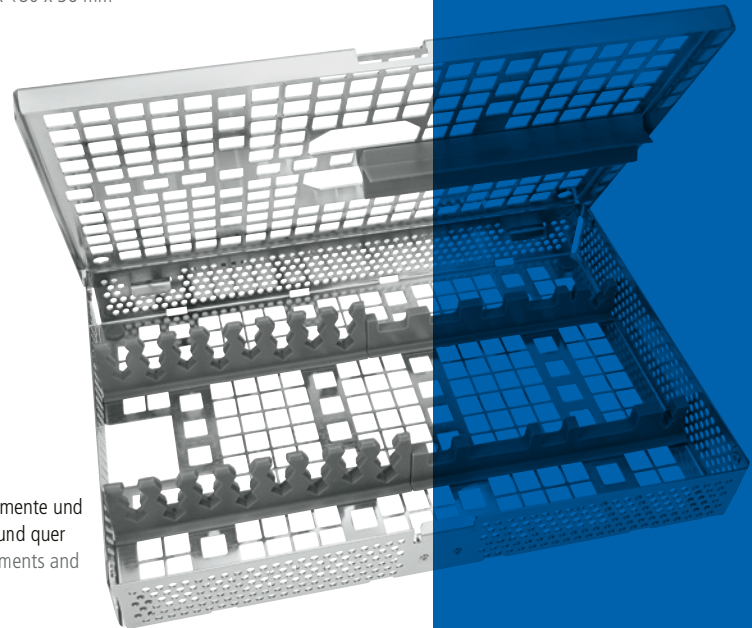

2603-07

SCHWERT Protector für 8 Handinstrumente und
Mikro-Instrumente, Einteilung längs und quer
SCHWERT Protect basket for 8 instruments and
4 micro instruments

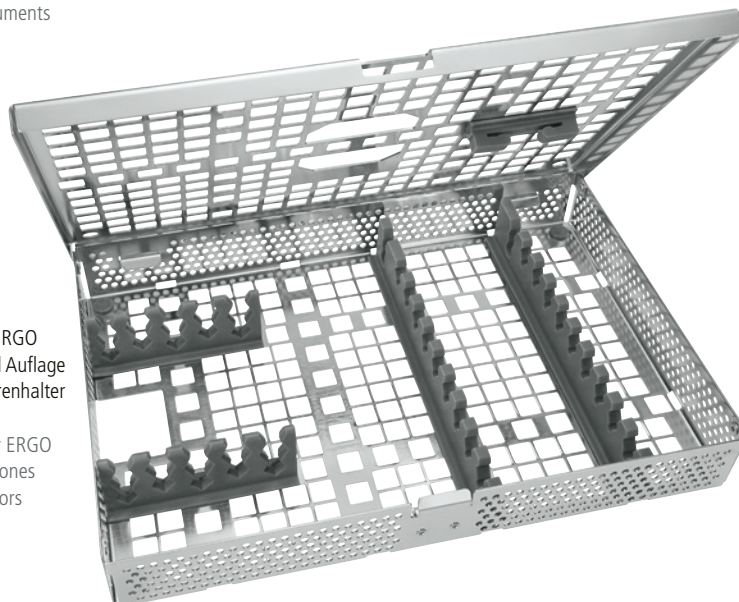

2603-08

SCHWERT Protector-Korb für ERGO
Chirurgie Set. Flache Universal Auflage
Zwei Querauflagen, inkl. Scherenhalter
266 x 180 x 36 mm
SCHWERT Protector basket for ERGO
Surgical Kit. Flat universal silicones
two silicones across, incl. scissors
holder in the lid,
266 x 180 x 36 mm